

# AIRFLOW

## iCONsmart® Smart Fan Installation and Operation Guide

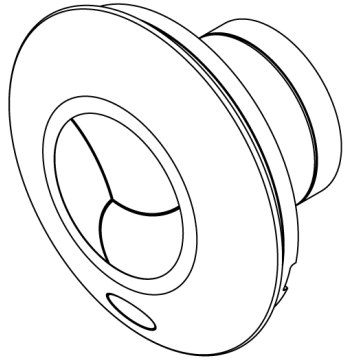

iCONsmart 15 T - 72687228  
 iCONsmart 15 HT - 72687229  
 iCONsmart 15 MST - 72687230  
 iCONsmart 15 MSHT - 72687231



### Electrical Installation

All electrical installation must be carried out by an approved electrician in accordance with Part "P" U.K. Building Regulations and to the latest IET standards, or the appropriate regulations in the country of installation. The iCONsmart 15 requires a 110V—240V 50/60 Hz single phase supply. The iCONsmart 15 is IPX5 rated and therefore it is suitable for mounting in bathrooms (in zone 1 and 2). For fans mounted in zones 1 & 2 as defined in BS 7671:2018, additional protection must be provided by a Residual Current Device (RCD) not exceeding 30mA as well as having an Arc Fault Detection Device (AFDD). A disconnector (e.g. Isolator switch, circuit breaker) with a distance greater than 3 mm between its open contacts shall be required according to BS 60669-1.

#### Basic Wiring

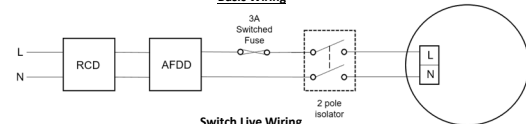

#### Switch Live Wiring

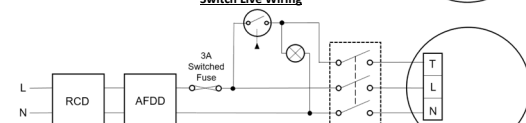

Important: Switches for fans should be selected and sited in accordance with BS 7671:2018.

### Fan Overview

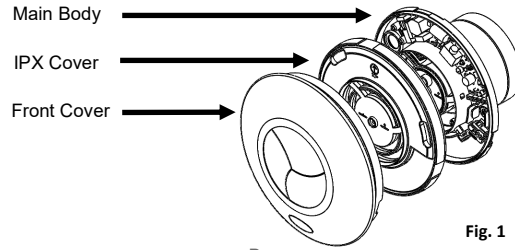

Fig. 1

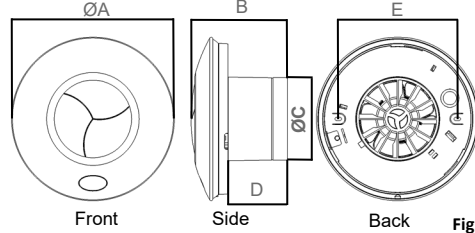

Fig. 2

Model	A	B	C	D	E
iCONsmart 15	194	118	100	72	144

**iCONsmart comes with a flow sensing technology that automatically adjusts and maintains the set extraction flow rates when within the parameters of the fan.**

### Installation

- Ensure selected power source being used is isolated.
- Front cover iris leaves must be in the fully closed position.
- Remove locking screw from the bottom of the **front cover**. (Fig.4)
- Hold the main body, turn the front cover anti-clockwise. Note front cover position for re-assembly purposes. Lift the cover off. (Fig. 4)

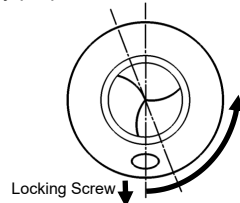

Fig. 4

- Remove the IPX cover by undoing the screw in the centre. Lift the IPX cover off. (Fig. 5)

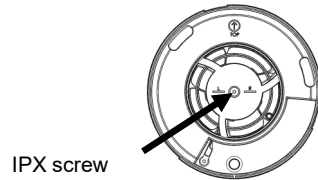

Fig. 5

iCONsmart has several features included as standard (the basic model part number is 72687221) or fitted with digital micro modules to give a range of extra control options.

### Standard Features

- Bluetooth connection to your smart device
- Setting flow rates
- Customise fan name
- Flow sensor
- 3 month rolling log of power consumption, time on and flow rates recording.

### Module Controls

Each fan model is supplied from the factory with a preinstalled control module. Available module types include: Timer (T), Humidity & Timer (HT), Motion Sensor & Timer (MST), or a combined Motion Sensor, Humidity & Timer module (MSHT). The module fitted will depend on the fan model selected.

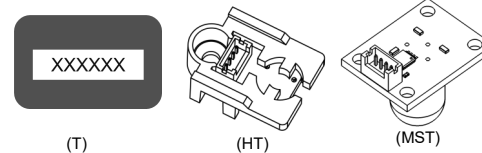

(T)

(HT)

(MST)

- Fit the sealing grommet supplied into the cable entry hole. (Fig. 6)
- Pierce the grommet to allow the mains cable to be fed through while maintaining seal integrity.

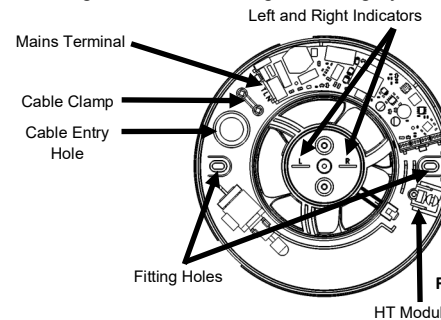

Fig. 6

- Position the fan so cable entry and fitting holes align with those on the mounting surface. Keep the tape on the fitting holes; screw through it.
- Feed through the cable and fit the fan. (Fig. 6) Offer up the supply cable to fan. Cut to length needed.
- Wire the fan to supply cable, referring to the electrical installation guide. (Page 5)
- Using the cable clamp provided, secure the mains cable into place.

Note: T/HT fans have a white lens; MST/MSHT fans have a translucent lens.

### Prepare Wall or Ceiling

The iCONsmart can be installed into a wall or ceiling. When fitting fans in the ceiling, if high density plasterboard is not used, a support (min 18mm thick) should be mounted between the ceiling joists. Fans should not be fitted to unsupported plasterboards. (Fig. 3)

Possible cable routing

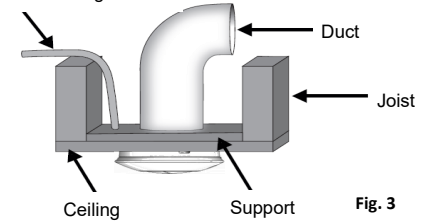

Fig. 3

- Mark out and drill a spigot hole to suit 100mm diameter rigid ducting.
- Make provision for the electric supply cable and wall plugs / appropriate fittings using the main body as a template. Level using guides below the L and R symbols. (see Fig. 6)
- Fit the wall plugs provided or fittings as appropriate for the surface.

- To replace the IPX cover, line up the L (Left) and R (Right) indicators on the main body of the fan (Fig. 6) with the L and R indicator on the IPX cover (Fig. 7). Lightly press the IPX cover onto the main body.
- Refit the IPX screw, checking the IPX cover is secure.

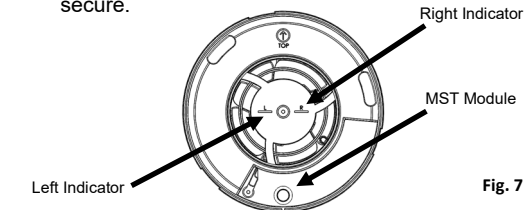

Fig. 7

- Position front cover over IPX cover in same orientation as it was removed. Lightly press front cover onto fan and rotate clockwise. Refit locking screw. (Fig. 8)

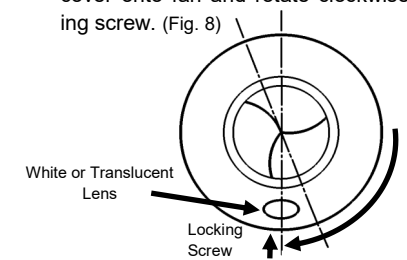

Fig. 8

## First Time Use

When the iCONsmart is first powered on, you will hear the initial reset for 10-15 seconds. This is normal and will also occur if the fan is in its reset mode.

## App Control and Setup

To activate the iCONsmart and to set it up:

- Download and install myAirflow from the App Store or Google Play Store to your smart device.
- Ensure Bluetooth is enabled on your device, then open the app. The smart device should be within 2 metres of the fan during setup and operation to ensure seamless connectivity. One smart device user controls the fan at a time.
- Follow the simple setup process shown on your screen. This includes setting the flow rates, fan naming and timer module settings. Ensure that the Save button (located in the top-right corner) is pressed to store the commissioning settings.

Note: If a new user connects to the same smart fan, they may choose to restore previous settings or use the default (factory) configuration.

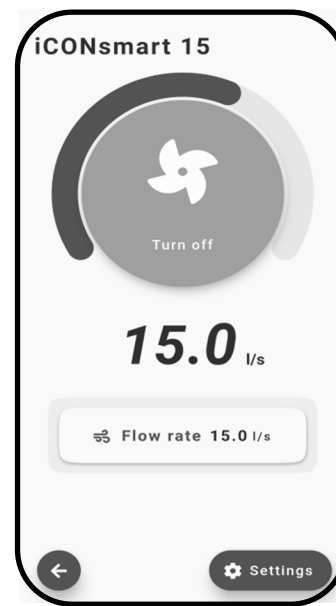

**Home** — From this page you can activate the fan, as well as viewing and adjusting the flow rate.

Page 9 of 16

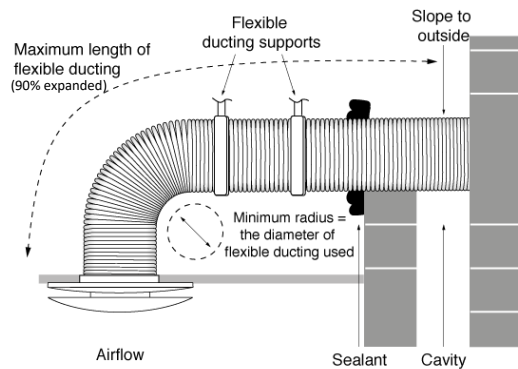

Ensure that flexible duct connections are not over tightened to the spigots. To maximise the air flow, rigid ducting should be used where possible. The fan and ducting should be installed in accordance with the requirements of the Domestic Ventilation Compliance Guide, Part F of the Building Regulations.

Where flexible ducting is used ensure it is pulled to 90% of its full length.

Page 13 of 16

Page 10 of 16

## Maintenance

**SAFETY FIRST: ALWAYS ISOLATE THE FAN UNIT FROM THE POWER SUPPLY BEFORE DOING ANY WORK ON THE FAN / MODULE.**

When installed by a competent installer according to user instructions, the iCONsmart range is completely safe. The materials used in its construction do not constitute a hazard. This appliance is not intended for use by persons (including children) with reduced physical, sensory or mental capabilities, or lack of experience and knowledge, unless they are supervised or fully instructed concerning the use of the appliance by a person responsible for their safety.

## Cleaning

Fan and ducting should be inspected and cleaned on a regular basis to maintain fan performance. The external housing of the fan can be wiped with a damp cloth.

Do not use household cleaners containing abrasives. Cleaning of the internal parts such as the impeller should be carried out by using a soft brush. Never clean any parts of the fan assembly by immersing in water or using a dishwasher.

Page 14 of 16

**Settings** — Contains all adjustable settings from the setup and more: Setting the flow rates, fan name, unlock timer functionality and all module parameters.

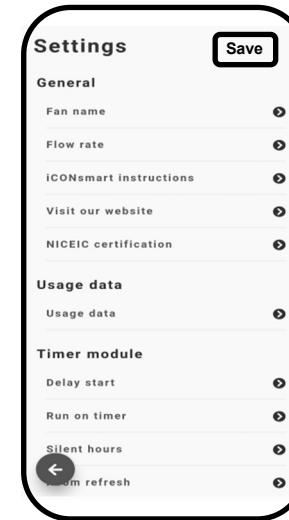

**Usage Data** — The iCONsmart can store up to 3 months rolling log of power use, time-on, flow rates, temperature and humidity levels (Requires the humidity module to be installed and connected to view temperature and humidity levels log).

Page 11 of 16

## Warranty

Airflow guarantees the iCONsmart and iCONsmart modules for 5 years from date of purchase against faulty material or workmanship. Applicable to units installed and used in the UNITED KINGDOM.

Warranty covers the fan, not the reinstallation of this if required. In the event of any defective parts being found, Airflow Developments Ltd reserves the right to repair, or at our discretion replace without charge, provided the unit:

- ⇒ Has been installed in accordance with the fitting and wiring instructions supplied with each unit.
- ⇒ Has not been connected to an unsuitable electrical supply.
- ⇒ Has not been subjected to misuse, neglect or damage.
- ⇒ Has not been altered by drilling and the plastic casing remains intact.
- ⇒ Has not been modified or repaired by any person not authorised by Airflow Developments Ltd.
- ⇒ Has been installed by a person who is recognised as a competent person who is part of a competent scheme provider.

Page 15 of 16

## Best Practice Recommendations

iCONsmart has been CB tested and FCC certified to demonstrate the thoughtful engineering behind the fan design. It has been awarded the TUV certification for its safety, functionality and quality.

Do not place the fan near any direct heat sources, e.g. radiant heaters, or where the ambient temperature can exceed 40°C (104°F).

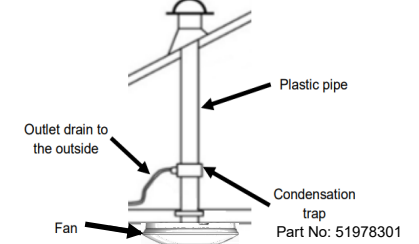

To avoid the backflow of condensation into the fan in ceiling installations Airflow recommends fitting a condensation trap to the outlet duct of the fan.

Where flexible ducting is used the diameter must be maintained and it is good ventilation practice that the ducting is extended to a minimum of 90% of its possible length in order to maintain the best possible air flow.

Page 12 of 16



Airflow Developments Ltd shall not be liable for any loss, injury or other consequential damage, in the event of a failure of the equipment or arising from, or in connection with, the equipment excepting only that nothing in this condition shall be construed as to exclude or restrict liability for negligence. Full details at [airflow.com/terms](http://airflow.com/terms)

**This warranty does not in any way affect any statutory or other consumer rights.**



### Disposal

Do not dispose of with household waste. Please recycle where facilities exist. Check with your local authority for recycling advice.



UK Head-Office	Czech Republic	Germany
AIRFLOW DEVELOPMENTS Limited Aidelle House, Lancaster Road Cressex Business Park High Wycombe Buckinghamshire HP12 3QP United Kingdom	AIRFLOW LUFTECHNIK GmbH o.s. Praha Hostýnská 520 108 00 Praha 10 Malesice Czech Republic	AIRFLOW LUFTECHNIK GmbH Postfach 1208 D-53349 Rheinbach Germany
Tel: +44 (0) 1494 525252	Tel: +42 (0) 2 7477 2230	Tel: +49 (0) 222 69205 0
Email: <a href="mailto:info@airflow.com">info@airflow.com</a>	Email: <a href="mailto:info@airflow.cz">info@airflow.cz</a>	Email: <a href="mailto:info@airflow.de">info@airflow.de</a>
Web: <a href="http://airflow.com">airflow.com</a>	Web: <a href="http://airflow.cz">airflow.cz</a>	Web: <a href="http://airflow.de">airflow.de</a>

Page 16 of 16